

IP TV and Internet TV

IP TV and Internet TV

- IPTV (Internet Protocol Television) is the service provided by a system for the distribution of digital TV over IP networks, using a dedicated network infrastructure
- For IP TV users, also the VoD service is usually available
- As opposed to IP TV, Internet Television uses the public internet to transport media







IP TV and Internet TV

- The IPTV service is provided through complex and costly infrastructures; investment and maintenance costs are high
- IP TV infrastructures can be used to transport high definition contents, allowing the provisioning of premium services
- Since Internet TV uses the public internet, the network service is Best Effort and no quality guarantees can be provided
- IPTV and Internet TV are not necessarily competing services: Internet TV can concentrate on the log tail of digital contents, while IP TV is more concentrated on high hit rate contents

IPTV

- ITU definition of IPTV:
IPTV is defined as multimedia services such as television/video/audio/text/graphics/data delivered over IP based networks managed to provide the required level of QoS/QoE, security, interactivity and reliability”
- IPTV services are offered through a closed and dedicated network; the provider can control quality parameters
- The IP TV service can be
 - **linear** (contents are scheduled in advance)
 - **not linear** (such as Video on Demand, VoD)
- IPTV adopts a “closed” network distribution model, while Internet TV is basically *network independent*

Typical IPTV bouquet of services

Live TV  <ul style="list-style-type: none">• Digital TV• Premium TV• Pay-per-view• Near video-on-demand• Program guide	Entertainment  <ul style="list-style-type: none">• Gaming• Gambling• Karaoke• Internet TV
Stored TV  <ul style="list-style-type: none">• Video-on-demand• Subscription VOD• Time-shifting PVR• Network PVR	Commerce  <ul style="list-style-type: none">• Telecommerce• Targeted/interactive advertising
Communications  <ul style="list-style-type: none">• Residential VOIP portal• Instant messaging• SMS/MMS messaging• Mobile services portal• Video conferencing• Emergency alert system	ASP  <ul style="list-style-type: none">• Distance learning• Home automation portal• Home security portal• Converged services• Hospitality

IPTV and Internet TV

	IPTV	Internet video streaming
Footprint	Local (limited operator coverage)	Potentially supranational or worldwide
Users	Known customers with known IP addresses and known locations	Any users (generally unknown)
Video Quality	Controlled QoS Broadcast TV quality	Best effort quality, QoS not guaranteed
Connection bandwidth	At least 4 Mbps	
Video format	MPEG-2 MPEG-4 Part 2 MPEG-4 Part 10 (AVC) Microsoft VC1	Windows Media RealNetworks QuickTime Flash, and others
Receiver device	Set-top box with a television display	PC
Resolution	Full TV display	QCIF/CIF
Reliability	Stable	Subject to contention
Security	Users are authenticated and protected	Unsafe
Copyright	Content is protected	Often unprotected
Other services	Electronic Programme Guide (EPG), PVR (local or network)	
Customer relationship	Yes, onsite installation and customer support	Generally no
Complementarity with cable, terrestrial and satellite broadcasting	Potentially common STB, complementary coverage	

Fonte: ITU, 2006.

The service chain of IPTV

- The content provider owns content or it has the authorization of selling them
- The Content Provider transfers contents to the service provider
Service Provider

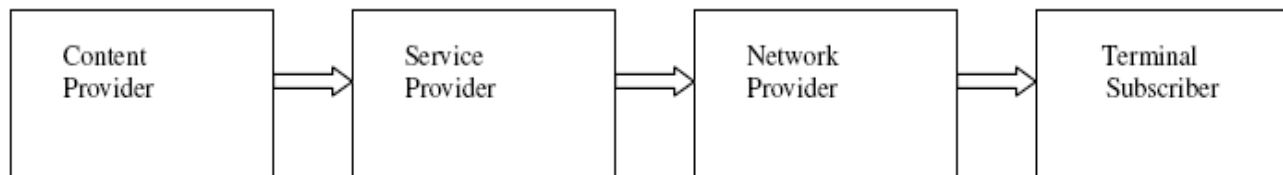

The service chain of IPTV

- The service provider distributed contents to users, it is responsible of:
 - Content distribution
 - Service management
 - User management
 - Content management
- The Service Provider aggregates contents to form service bouquets distributed through
 - Traditional channels (satellite, DVB, ...)
 - Video on Demand
 - PVR (Private Virtual recorder)
 -

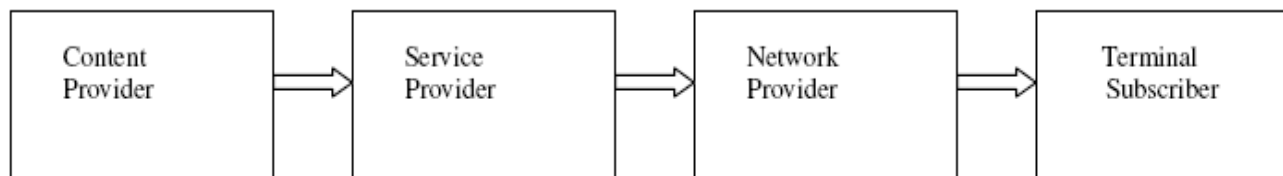

The service chain of IPTV

- Activities of the service provider
 - Content Ingestion:
 - Contents are acquired from the content provider; in some particular cases contents may be produced by the service provider itself

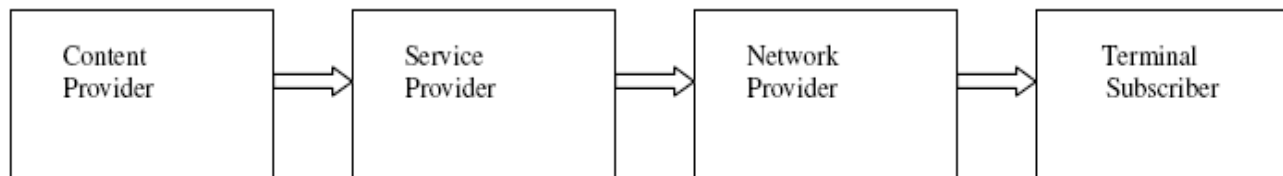

The service chain of IPTV

- Activities of the service provider
 - Encoding/transcoding:
 - The content must be coded in a format suitable for the transport through the network

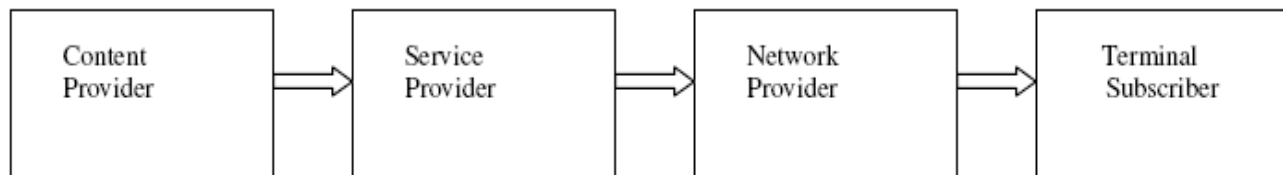

The service chain of IPTV

- Activities of the service provider
 - Encoding/transcoding:
 - The content must be coded in a format suitable for the transport through the network

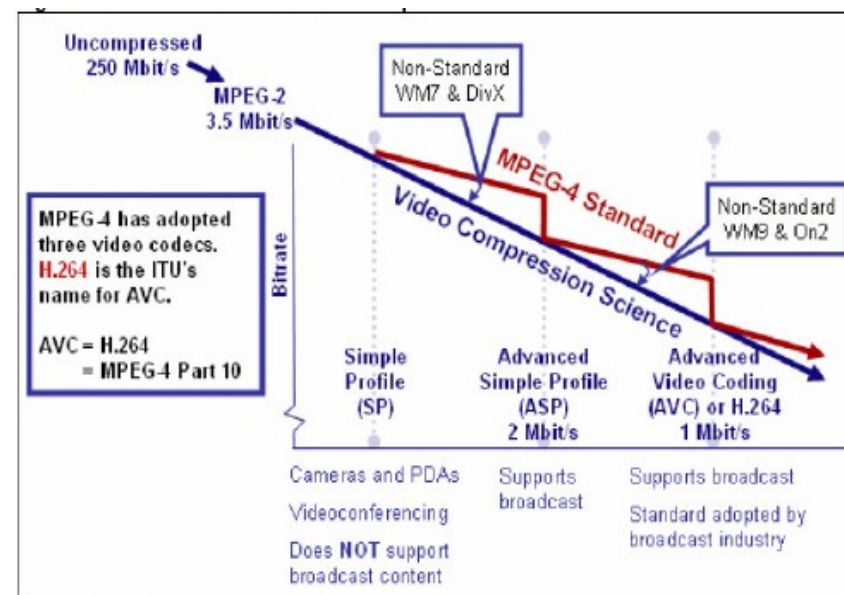

Source: Envivio

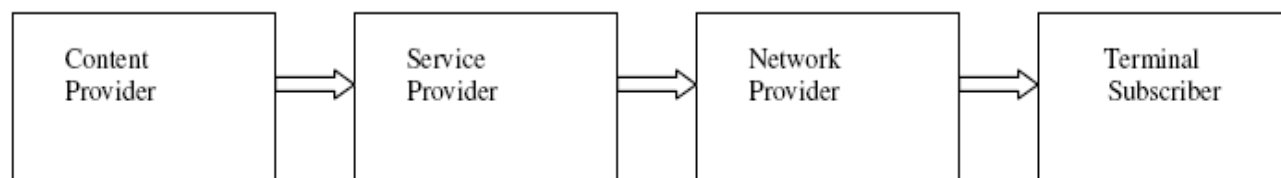

The service chain of IPTV

- Activities of the service provider
 - Media asset management:
 - Management of the content archive, compilation and maintenance of content metadata, content search and user transaction management

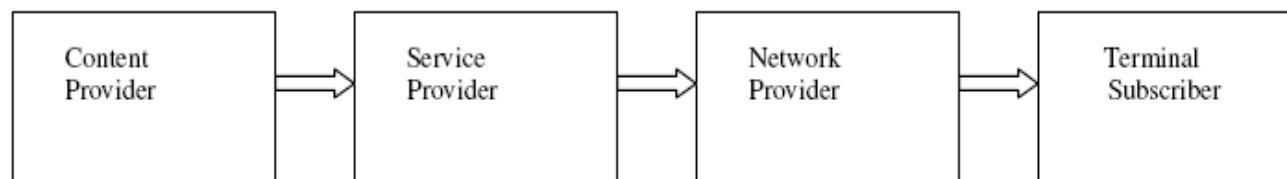

The service chain of IPTV

- Activities of the service provider
 - Digital Rights Management:
 - Contents must be protected from illegal usage
 - Security systems such as conditional access are widely employed
 - Storage of content on the user's device is regulated: only for a limited time period, and contents are encrypted

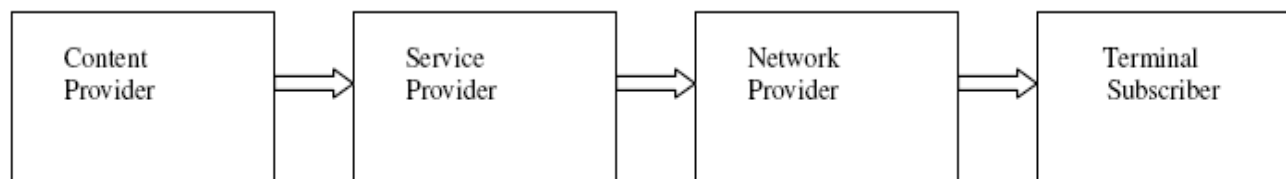

The service chain of IPTV

- The Network Provider connects users and the service provider
- It is responsible of the transport of media, of the associated Quality of Service (QoS)

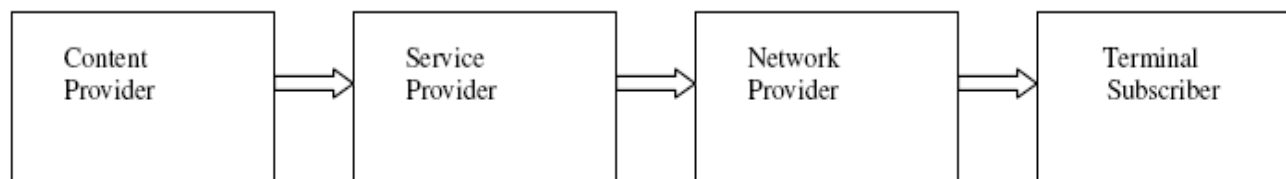

The service chain of IPTV

Usually the distribution of servers is hierarchical, to provide caching and local storage to reduce costs

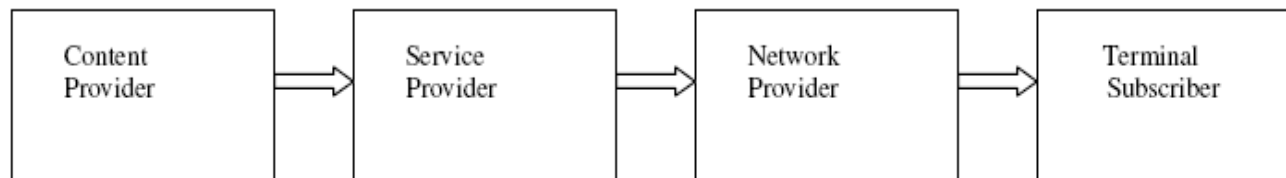
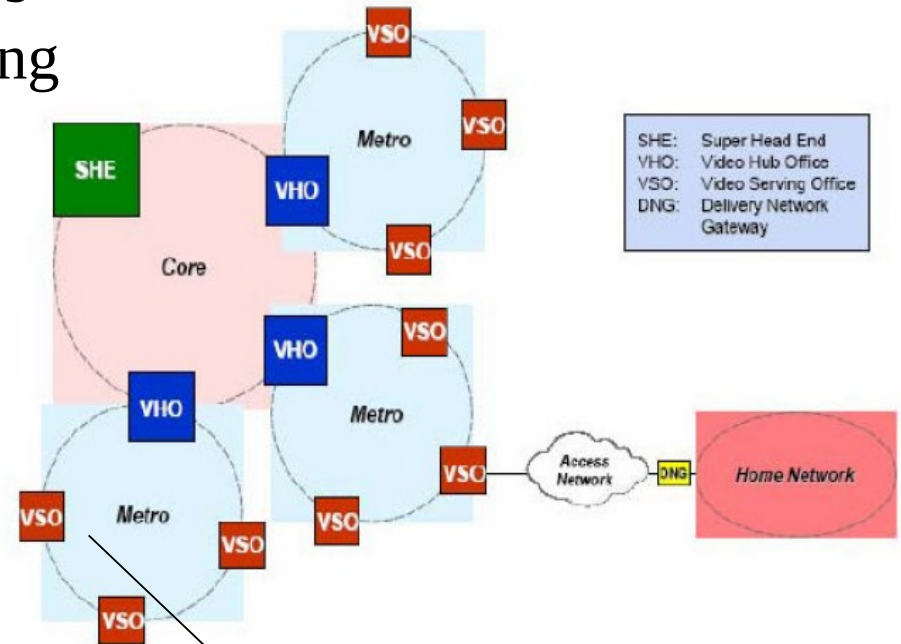

The service chain of IPTV

- The user receives contents and pays for them
- Usually, the user's device is a set-top-box

